

**METALSISTEM**<sup>®</sup>



catalogue  
**SUPERBO**

modular storage systems

# METALSISTEM Group

see more  
on the web



## SERVICES



121 Granton Drive, Unit #17  
Richmond Hill, ON, CANADA, L4B 3N4  
Tel. +1 905 8869499 | Fax +1 905 8866890  
info@metalsistemcanada.com  
www.metalsistemcanada.com



9B International square,  
Tullamarine, VIC, 3043 - AUSTRALIA  
Tel. +61 03 9310 5939 | Fax +61 03 9310 5938  
info@metalsistemaustralia.com  
www.metalsistemaustralia.com



3201 Fox St. Philadelphia, PA 19129 USA  
Tel. +1-866-412-5558 | Fax +1-905-866-6890  
info@metalsistemnorthamerica.com  
www.metalsistemnorthamerica.com



Rue de l'Industrie 4-6 - Z.I.  
L-8399 Windhof - LUXEMBOURG  
Tel. +352 39 72 06 | Fax +352 39 92 30  
info@luxmetalsistem.eu | www.luxmetalsistem.eu



6855 Stabio - SWITZERLAND  
Via Gaggiolo, 27  
Tel. +41 91 210 32 99  
info@metalsistem.ch | www.metalsistem.ch



91220 Le Plessis Paté, Paris - FRANCE  
11, Rue Leonard de Vinci - Z.I. Du Parc  
Tel. +33 1 60851845 | Fax +33 1 60849554  
info@metalsistem.fr | www.sidac-metalsistem.fr



08110 Moncada | Reixac, Barcelona - SPAIN  
C/Narcis Monturiol n° 4 nave 14  
Tel. +34 935 651 800 | Fax +34 935 651 801  
sidac-iberia@sidac-iberia.com | www.sidaciberia.com



38068 Rovereto (TN) - Italy, Viale del Lavoro, 1  
Tel. +39 0464 486124 | Fax +39 0464 400430  
info@metalsistemitalia.it | www.metalsistemitalia.it



38068 Rovereto (TN) - Italy, Viale del Lavoro, 1  
Tel. +39 0464 303290  
info@metalsisteminternational.com  
www.metalsisteminternational.com



41012 Carpi (MO) - Italy, Via C. Marx, 113  
Tel. +39 059 696 450 | Fax +39 059 642 479  
info@metalsistememilia.it | www.metalsistememilia.it



20090 Buccinasco (MI) - Italy, Via E. Fermi, 6  
Tel. +39 02 45708646 | Fax +39 02 45708647  
info@metalsistemlombardia.it  
www.metalsistemlombardia.it



60028 Osimo Stazione (AN) - Italy, Via Maestri  
del Lavoro, 17  
Tel. +39 071 710 86 60 | Fax +39 071 710 84 85  
metalsis@tin.it | www.metalsistemmarche.it



10028 Trofarello (TO) - Italy, Via Torricelli, 39  
Tel. +39 011 649 75 69 | Fax +39 011 649 84 69  
info@metalsistempiemonte.com  
www.metalsistempiemonte.com



00040 Pomezia (RM) - Italy, Via dei Castelli Romani, 8  
56/58  
Tel. +39 06 91801333 | Fax +39 06 91621141  
info@metalsistemroma.it | www.metalsistemroma.it



07100 Sassari (SS) - Italy, Z.I. Predda Niedda  
Nord, str. n. 3  
Tel. +39 079 260 559 | Fax +39 079 263 3604  
info@metalsistemsardegna.com  
www.metalsistemsardegna.com



35011 Campodarsego (PD) - Italy, Via Pontarola, 13/B  
Tel. +39 049 9201696 | Fax +39 049 9201236  
info@metalsistemline.it | www.metalsistem.com



63076 Monteprandone Centobuchi (AP) - Italy  
Via del Lavoro, 16  
Tel. +39 0735 704880 | Fax +39 0735 710413  
info@blocksystem.it | www.blocksystem.it



90121 Palermo (PA) - Italy, Via Messina Montagne, 8  
Tel. +39 091 492 351 | Fax +39 091 492 351  
glsistem@inwind.it | www.glsistem.com



21013 Gallarate (VA) Italy, Via Monte Leone, 25  
Tel. +39 0331 79 36 19 | Fax +39 0331 77 04 07  
info@luonisistem.it | www.luonisistem.it



31020 Fontane di Villorba (TV) - Italy  
Via Donatori del Sangue, 5/II  
Tel. +39 0422 911994 | Fax +39 0422 912085  
info@sidacveneto.com | www.sidacveneto.com



70017 Putignano (BA) Italy, Via Maestri del  
Lavoro n.c. - Z.I.  
Tel. +39 080 405 41 54 | Fax +39 080 405 41 43  
info@smetar.it | www.smetar.it



50041 Calenzano (FI) - Italy, Via del Pratigione, 70  
Tel. +39 055 887 36 33 | Fax +39 055 887 46 52  
info@soteasistem.com | www.soteasistem.com



25124 Loc. Folzano (BS) - Italy, Via Tito Baresani 13/15  
Tel. +39 030 266508 | Fax +39 030 2160301  
info@teknosistem.it | www.teknosistem.it



37060 Caselle di Sommacampagna (VR) - Italy  
Via dell'Artigianato, 24  
Tel. +39 045 858 12 12 | Fax +39 045 858 11 66  
info@vierresistem.it | www.vierresistem.it

## PRODUCTION



SISTEMI E STRUTTURE PER IL MAGAZZINO  
38068 Rovereto (TN) Italy, Viale dell'Industria, 2  
Tel. +39 0464 30 30 30 | Fax +39 0464 30 30 31  
info@metalsistem.com | www.metalsistem.com



25064 Gussago (BS) Italy, Via Mandolossa, 100  
25020 Gamba (BS) Italy, Villaggio Europa, 8  
Tel. +39 030 2526 511 - Fax +39 030 956110  
info@metalsistem.com - www.metalsistem.com



31045 Motta di Livenza (TV) Italy  
Via Friuli, 32 - Z.I. Sud  
Tel. +39 0422 863035  
Fax +39 0422 861939



Slavkov 284 - 687 64 Horni Nemci (UH)  
Repubblica Ceca  
Tel. +420 572 648615 | Fax +420 572 648071  
kredit@oskredit.cz | www.kredit.cz

# The Group

Founded in 1968, METALSISTEM commenced its activities specializing in the design and production of machinery for the cold profiling of metals. The experience gathered, numerous highly innovative patents resulting from intense research and development and the considerable market success of the first range of cold form zinc coated profiles quickly channeled METALSISTEM into the production of the latter of its activities.

Today the METALSISTEM Group is an articulated network of companies with its head office and main production facilities in Rovereto, Italy.

The Group has consolidated its position as one of the major industries within the Material Handling and shopfitting sectors.

Through products and services aimed at providing complete assistance for all warehousing, product showcasing and shops requirements, METALSISTEM Group companies are able to offer their costumers a wide range of products of the highest quality, highly competitive priced, with very rapid delivery time and a first class customer service, as well as customized solutions providing efficient and rational use of internal storage areas, material handling environment as well as sales spaces.

With its SIDAC brand, METALSISTEM is able to provide innovative and functional shopfitting solutions for small shops but also large hypermarkets by developing a great number of products and accessories of certified quality, to meet any

display need. The SIDAC brand is renowned for its versatile and elegant accessories, quality finishes, high grade materials, robust structure and a wide range of innovative display shelving.

Lightness, strength and modular form, coupled with the ease of integrating and expanding already existing structures are but a few of the successful features of the METALSISTEM storage and shelving systems. A direction which has produced numerous international patents (testament to the uniqueness of the METALSISTEM products), continuing improvement in safety quality and versatility.

The numerous product lines are conceived and designed by METALSISTEM's internal Research & Development Center, as are the profiling lines and equipment required for their manufacture.

The automated production facilities have enabled METALSISTEM to achieve one of the highest levels of productivity in the world today.

Rigorous laboratory tests are conducted on the raw material entering production and on the final product, thus ensuring the continuing evolution of efficiency and quality standards.

All products have elevated structural characteristics and ensure high quality standards recognized by the most important European Certification bodies, such as Germany's TÜV Product Service GmbH and CISI (Costruttori Italiani di Scaffalatura Industriale), the latter of which METALSISTEM has membership.

The company's ISO 9001 quality assurance system as well as its environmental management system ISO14001 and the health and safety BS OHSAS 18001 are certified by RINA. METALSISTEM is also certified with the AEO FULL (Authorized Economic Operator) Certification and others.

With an annual turnover of exceeding 260 million Euro, the METALSISTEM Group premises occupy a total area of 230.000m<sup>2</sup>, 125.000 of which are dedicated to production.

The METALSISTEM Group's affiliated companies and distributors provide a worldwide commercial network, able to satisfy the most demanding needs.

We value greatly the high level of trust that is placed in us by our customers and feel that it is proof of the quality and reliability of our products.



See more on the web

ROVERETO - TN - THE HEADQUARTER



ROVERETO - TN - PREMISES AERIAL VIEW



# Safety Standards and Calculation Assumptions

A product's correct technical application and its visual appearance distinguishes both the customer and the manufacturer. METALSISTEM recommends that customers make use of this product professionally and in strict conformity with the applicable Standards and the technical characteristics described in this manual.

The design and assembly of projects must be conducted by expert and qualified personnel. METALSISTEM declines any responsibility for improper or inappropriate use of its products or noncompliant uses without prior written approval.

## a) Tolerances, deformations and clearances

This manual considers class 400 (wide and narrow aisle without automation) and class 300 (very narrow aisle without automation) pallet racking installations as defined by the UNI EN 15620 standards.

Installations of classes other than these need more stringent structural and deformation characteristics which require the intervention of the METALSISTEM Technical Office.

### a1) Suitability of the floor

Before commencing a project the suitability, or adequacy of the pavement, or floor slab to support the installation loads must be confirmed. The client must supply the necessary technical data for this evaluation. Unless otherwise expressly mentioned, the floor tolerances shall be in accordance with the UNI EN 15620 Standard.

### a2) Clearances

The minimum installation operating tolerances and clearance of the installation from the building and its fixtures must be agreed with the client, using the UNI EN 15620 standard as reference.

## b) Assembly

The rack assembly must be carried out by specialized personnel in conformity with national occupational and safety laws and the information contained in this Technical Manual. Particular attention must be taken to ensure that all frame bracing components are tightly bolted and that all safety apparel has been properly assembled (Refer also to the "Pallet Racking Operating and Maintenance Manual code MUM01").

## c) Rack alignment

The vertical plumb of the pallet racking frames must be checked along both the depth (Z) and length (X) directions. The UNI EN 15620 standard states that, unless more restrictive tolerances have been specified, the maximum permissible deviation off both directions must not exceed

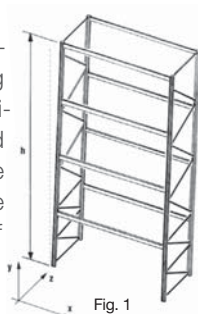

Fig. 1

H/350 for class 400 installations and H/500 for class 300 installations, where H represents the height of the uprights expressed in millimeters (Fig. 1). Refer to the "Pallet Racking Operating and Maintenance Manual MUM01" for a more detailed tolerance explanation.

## d) Safety signage and load bearing capacity plaques

Refer to National legislation for guide lines regarding the application of safety signage to installations. In Europe, the 92/58/EEC directive and its amendments provide the minimum acceptable level of safety signage regarding occupational health and safety in the work place.

The minimum level of safety signage that must be placed on every installation include:

- Generic warning plaque (consisting in an exclamation mark) (Italian legislative decree 81/08, attachment XXV);
- Load bearing capacity plaque formatted as an information sign. These must be placed in clearly visible locations showing year of assembly as well as the frame series, its load bearing capacity, the beam pair load or shelf bearing capacity (uniformly distributed load), load unit, height of the first beam from ground and the number of levels (Fig. 2).

METALSISTEM	
PER CARATTERISTICHE E INFORMAZIONI RIFERITE AL CATALOGO TECNICO	
REF. n°:	SYSTEM: SB05 YEAR: 2016
FRAME LOAD CAPACITY (U.D.L.)	daN: 10800
BEAM LOAD CAPACITY PER PAIR (U.D.L.)	daN: 2700
LOAD UNIT	daN: 900
DISTANCE BETWEEN GROUND AND FIRST BEAM LEVEL	mm: 1000
N° OF LOAD LEVELS	n°: 4

Fig. 2

It is also advisable to provide:

- Clearly marked emergency exits and prohibited dangerous areas.

## e) Racking safety standards

Frames must always be fixed to the floor slab with a minimum of two (2) M10x80 anchor bolts per upright.

In applications where the frame height is greater than 5 times the frame depth for single side rows, or 10 times the frame depth in double side rows, the racking must be accessorized with portal ties or wall ties. Note that walls ties are possible only after confirmation of the walls structural adequacy which must be confirmed by the property owner prior to their application. It is strictly prohibited to tie to walls in seismic areas.

Double side frames are defined as a pair of frames placed one behind the other and connected by pairs of adequately dimensioned spacer bars placed at the connection points of the frame diagonal spacer bars or however never more than 2000 mm apart.

The use of portal ties may be avoided in single entry runs if the following instructions are applied.

For frame base to height ratios: **up to 1:5**: standard frame bracing; **between 1:5 and 1:6**: frame with 8 short diagonal spacer bars; **between 1:6 and 1:7**: frame with 8 short diagonal spacer bars - maximum bay length of 2720mm

with 20% reduction in the admissible frame load bearing capacity for unbraced rows - 10% reduction in the admissible frame load bearing capacity for braced rows. Upright protection must be provided to all frames subjected to the risk of collision by material handling equipment (refer to "Pallet Racking Accessories Manual", code MT07).

#### f) Reference standards

The structural calculation reference standard are:

- UNI EN 15512:2009 "Steel static storage systems - Adjustable pallet racking systems - Principles for structural design";
- UNI EN 15620:2009 "Steel static storage systems - Adjustable pallet racking - Tolerances, deformations and clearances";
- UNI EN 1993-1-1:2005 "Eurocode 3 - Design of steel structures - Part 1-3: General rules and rules for buildings";
- UNI EN 1993-1-3:2007 "Eurocode 3 - Design of steel structures - Part 1-3: General rules - Supplementary rules for cold-formed members and sheeting";
- UNI EN 1993-1-8:2005 "Eurocode 3 - Design of steel structures - Part 1-8: Design of joints".

Materials reference standards:

- UNI EN 10346:2015 "Continuously hot-dip coated steel flat products - Technical delivery conditions";
- UNI EN 10149-1:2013 "Hot-rolled flat products made of high yield strength steels for cold forming. General delivery conditions.";
- UNI EN 10149-2:2013 "Hot-rolled flat products made of high yield strength steels for cold forming. Delivery conditions for thermomechanically rolled steels";
- UNI EN 10204:2005 "Metallic products - Types of inspection documents" (3.1 certificate).

Other reference standards:

- UNI EN 15635:2009 "Steel static storage systems - Application and maintenance of storage equipment";
- UNI EN 1090-1:2012 "Execution of steel and aluminium structures - Part 1: Requirements for conformity assessment of structural components.";
- UNI EN 1090-2:2011 "of steel and aluminium structures - Part 2: Technical requirements for steel structures";
- ACAI-CISI testo unico del 11/05/2004: "Technical standards for pallet racking";
- ACAI-CISI testo unico del 26/02/2004: "Self certification regulations".

#### g) Structural component testing

The structural engineering calculations are based on results derived from laboratory testing conducted by the Engineering Faculty of the University of Trento, Italy, and by the laboratories of the METALSISTEM Research Centre.

#### h) Structural calculations

The structural calculations have been made using the finite element method with the ANSYS, STRAUS7 and IT.RACKS! programs following the UNI EN 15512 standard.

#### i) Beam pair load bearing capacities

The beam pair load bearing capacities have been calculated using the following assumptions:

- uniformly distributed load;
- calculations in accordance with the UNI EN 15512 standard, with material factors  $\gamma_{M,0} = \gamma_{M,1} = 1,1$ ,  $\gamma_{M,2} = 1,25$ ;
- beam pair collapse safety coefficient minimum of 2;
- maximum deflection of 1/200 of the beam length;
- the mandatory installation of safety pins to beams;
- specific conditions listed under the load bearing capacity tables.

The load bearing capacities of the beams are based on the use of Euro pallets in a good state of repair.

#### j) Frame load bearing capacities

The tables contained in the Technical Manual are used to find the frame series that match the load demands of a pallet racking installation as a function of the height from ground of the first pair of beams (first loading level), the beam series, the length of the beam and of the height of the frame.

These tables are applicable to pallet racking with:

- a distance between levels equal to or less than the height of the first beam from ground;
- an equal load acting on all levels;
- permissible sway (movement) deformation in accordance with the UNI EN 15620 Class 300 and Class 400 pallet racking;
- calculations in accordance with the UNI EN 15512 standard, with material factors  $\gamma_{M,0} = \gamma_{M,1} = 1,05$ ,  $\gamma_{M,2} = 1,25$ ;
- every upright anchored to ground with a minimum of two (2) anchor bolts;
- compliance with the specific conditions listed under the load bearing capacity tables.

Given that the load bearing capacity of the frame is also dependent from other factors (height of beam from ground equal to or more than the centre distance between the bay beams, frame base to height ratio, seismicity of the area, environmental factors such as vibrations, atmospheric conditions, etc.) contact the METALSISTEM Technical Offices regarding doubts concerning non-standard applications, large or complex installations requiring optimization, or structural controls for specific solutions.

The frame load bearing capacities have been determined considering horizontal forces induced by imperfections as defined by the UN EN 15512 standard. Horizontal forces due to wind, vibrations, impact, seismic activity or other have not been considered. If these conditions apply, contact the METALSISTEM Technical Department. The EN15512 Standards apply material factors which may vary between the European member states with  $\gamma_{M,0}$  values ranging from 1.0 to 1.1. The METALSISTEM frame load bearing capacity tables have taken a  $\gamma_{M,0}$  value of 1.05. Clients of member states which apply other  $\gamma_{M,0}$  values shall contact the METALSISTEM Technical Office.

### **k) Installation environment, use and maintenance of the product**

The load bearing capacities and the material finish assume that the product is assembled in dry internal environments. Applications in external or highly aggressive environments forfeit the guarantee of the surface treatment. Contact the METALSISTEM Technical Department for structural verification of outdoor applications.

For guidelines regarding use of the installation and programmed component inspection, required by the UNI EN 15635 standards, refer to the "Pallet Racking Operating and Maintenance Manual MUM01".

### **l) Bracing**

The bracing system, composed of a bracing tower or by cross bracing, its frame connection accessories and horizontal cross bracing components, is a structural element which limits the movement of the racking.

This system is designed to absorb the horizontal forces caused by plumb errors and by the placement of the merchandise as defined by the UNI EN 15635 standards.

### **m) Raw material**

The 3.1 certificate (UNI EN 10204 standards) guarantees the mechanical properties of the high tensile structural steels used by METALSISTEM production.

The mechanical properties of the structural steel may vary from between S315 to S355 for pickled steels and between S350 and S400 for galvanized steels (UNI EN 10346 and UNI EN 10149) depending on the components structural application.

The surface treatment of the structural steels may either be hot dip galvanized using the SENDZIMIR process or powder coated pickled steel.

### **n) Bolted assemblies**

Local standards and norms could mandate, for specific installations, to equip the racking system with CE-marked bolts. The CE marking according to EN 15048-1 regards the assembly (bolt + nut), and requires to provide sealed packages containing both the components. METALSISTEM provides a selected choice of CE marked assemblies which can be used alternatively to standard bolts and nuts. The full list of order codes for CE marked bolted assemblies can be found in the "Pallet Racking Accessories Technical Manual", code MT07.

### **o) Anchoring**

The standard anchoring method which METALSISTEM provides for static conditions, in absence of seismic actions, considers expansion anchor bolts which are CE marked according to ETAG 001 Annex C – Option 7.

Alternative anchor bolts, which can be used for specific load- or assembly conditions, are available for order.

Independent of the adopted anchor bolt, METALSISTEM recommends to strictly comply to all the instructions of use provided by the anchor bolts manufacturer, to ensure the safety of the anchoring.

Please contact METALSISTEM Technical Office for any additional information.

### **p) Fire protection**

Refer to the "Pallet Racking Operating and Maintenance Manual MUM01" document for information regarding standard applications, reaction and resistance to fire. It is the duty of the racking installation designer to check if the client requires the installation to have allowances for the integration of fire protection measures.

### **q) Controls**

The raw material entering production sustains ongoing testing by METALSISTEM internal Quality Control Department. The tests confirm the mechanical properties (elongation, yield, rupture), dimensional characteristics (gauge and width) surface finish (absence of defects, uniformity, resistance of coating).

METALSISTEM has its own internal testing facilities able to conduct SIT (Servizio di Taratura in Italia) certified tensile tests (approx. 1000 per year), dimensional tests and performance tests (stub column, nodal stiffness, shear and deflection) on finished product. Saline mist, scratch resistance and other tests are conducted by external facilities.

Testing of finished products are conducted by both the internal METALSISTEM Quality Control Office and externally by the product certifying agency TÜV. The system certifying agency RINA guarantees consistent product quality.

### **r) Certifications**

METALSISTEM production has been certified by the following international standards:

- Centro di Trasformazione – Italian metal fabricator certificate No. 753/10;
- Environmental Management System – ISO 14001;
- Quality Management Standard – ISO 9001;
- TÜV test compliance certificate;
- CISI – Quality and safety;
- AEO FULL – Authorised Economic Operator;
- UNI EN ISO 3834 – Qualified welding processes;
- EN 1090-1 – Certificate of conformity of the factory production control.

### **s) Safety apparel**

The installation designer, in consultation with the client, must review the type, locations, and needs of the safety apparel to be fitted to the installation (e.g.: upright and frame protection, floor guide rails, safety netting, walkway protection and covers, seismic design, fire system) in accordance with the risk and use of the areas under examination.

### **t) Customized applications**

Contact the METALSISTEM Technical Office for solutions and / or calculations of non-standard applications. METALSISTEM reserves the right to modify the technical characteristics of its products at any time it sees fit.



## The Company Today

METALSISTEM products are now in use in many installations throughout the world, and after more than 45 years production, we value greatly the high level of trust that is placed in us by our customers and feel that it is proof of the quality of our products.

The shelving and racking components are produced on fully automated production lines. The folding and cold processing techniques developed by METALSISTEM are designed to obtain light and extremely strong components.

Lightness, strength and modular form, coupled with the ease of integrating and expanding already existing structures are but a few of the successful features

of the METALSISTEM Industrial Storage Systems. Ideal storage solutions for a whole host of products supplied worldwide are created here thanks to a total commitment to research and development.

The METALSISTEM Technical Department is at the complete disposal of its customers, to study their individual needs and to propose the most effective solutions.



See more on the web





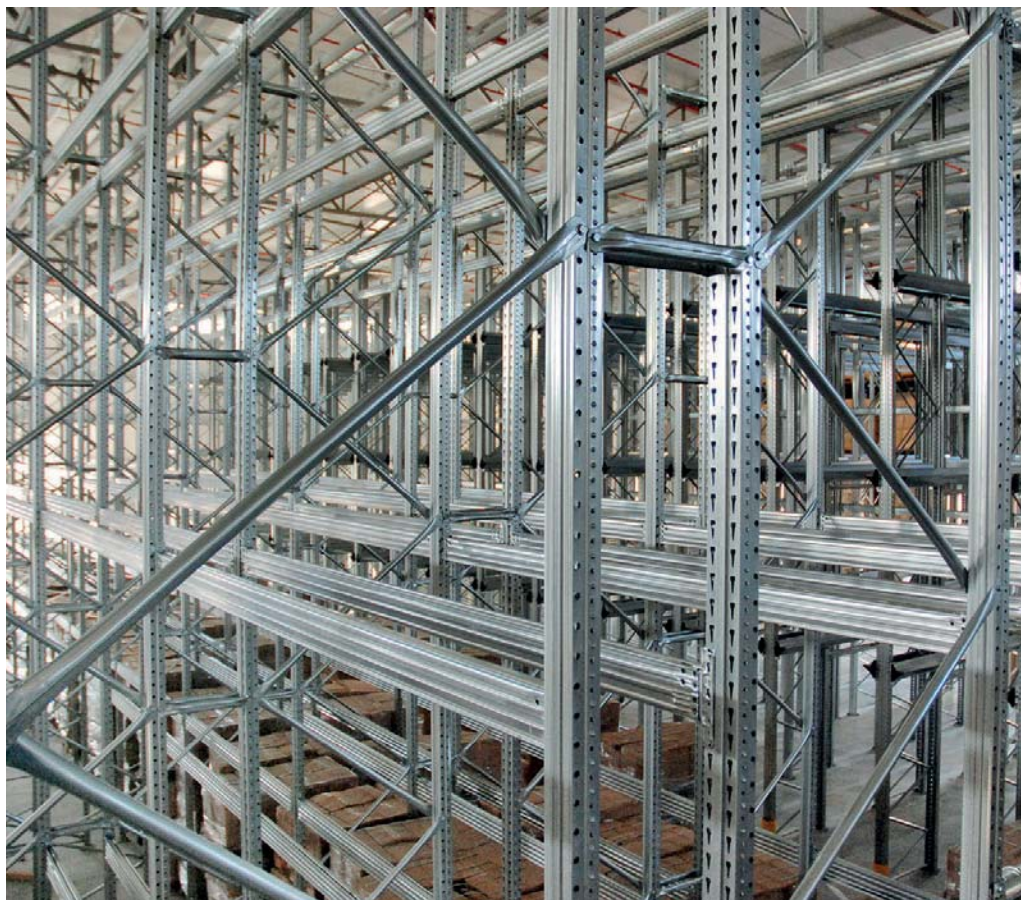



# The Product

SUPERBO 4-5-6-7 series are interchangeable with the SUPERBUILD and UNIBUILD heavy duty pallet racking series and have been designed to satisfy all requirements of medium to heavy duty pallet storage.

SUPERBO 4-5-6-7 series are available in four different frame load options, up to 18 tons.

The SUPERBO series are well known for their utmost performance in terms of resistance against torsional deflection, thanks to the closed box section of the uprights. Thanks to the rigidity of the frame, SUPERBO provides significant resistance against rupture and deformation and good performance in case of accidental impact.

The frames are made from prime quality, certified, high tensile, hot dipped galvanised steels (procedure SENDZIMIR), thus ensuring a high level of durability. All structural components are made from high tensile steels, certified 3.1 according to EN 10204. The frames are assembled using threaded rivets and screws, allowing for an easy and quick assembly and providing utmost rigidity of the connection between uprights and frame bracing components.

The beams are profiled sections with quadruple gauges at points of maximum stress for high loading capability. A channel running along the top face of the beam provides a lip within which a variety of components may be inserted, such as shelf panels, secondary beams, drum cradles and a.o. (see next pages). Beams with riveted, double sided beam connectors distinguish themselves by an optimised upright/beam connection, featuring utmost mechanical precision regarding beam length and position of the connector.

A wide range of load capacity options is available to provide the best possible beam load bearing options for each application, thus ensuring the very best cost efficiency.

As far as the beam surface is concerned, the following options are available:

- entirely zinc coated beams, zinc coating according to the SENDZIMIR procedure, featuring zinc coating at the inside and outside of the beam profiles;
- zinc coated and additionally powder coated beams for utmost protection;
- powder coated beams made from pickled steel.

Zinc coated beams, thanks to the absence of welding seams, are less subject to oxidation and fragility when used in cooling rooms.

All SUPERBO beams can be adjusted in height at intervals of 50 mm, thus facilitating the best use of available space.

## The unique beam-upright connection has a series of distinctive features, including:

- The double sided connectors of all riveted beams guarantee unparalleled nodal performance;
- Front facing connection of riveted beam with up to 5 anchor points, 3 of them operating in tension and 2 in compression;
- The connection between beam and upright is made with tapered slots in the upright section increasing performance with higher loads;
- The unique features of the patented beam connection lock the brackets in position while impairing beam rotation and improving load bearing capacity.



See more on the web

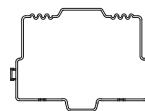

Superbo upright section

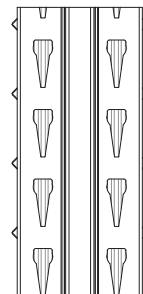

Superbo upright





# Main Structural Components

The design of the various components is the result of rigorous technical testing and the highly specialised knowledge developed over years of experience in the field of metal processing.

This experience has enabled METALSISTEM to offer innovative products of the highest quality, highly com-

petitively priced, and to provide a highly technical solution to the most important storage problems, such as rapid assembly, stability, low cost and load bearing capacity.

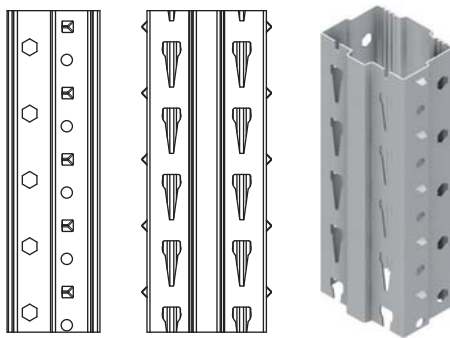

**1** Superbo upright

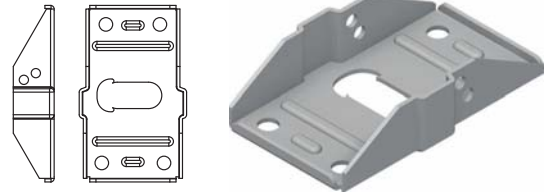

**2** Heavy duty metal base plate

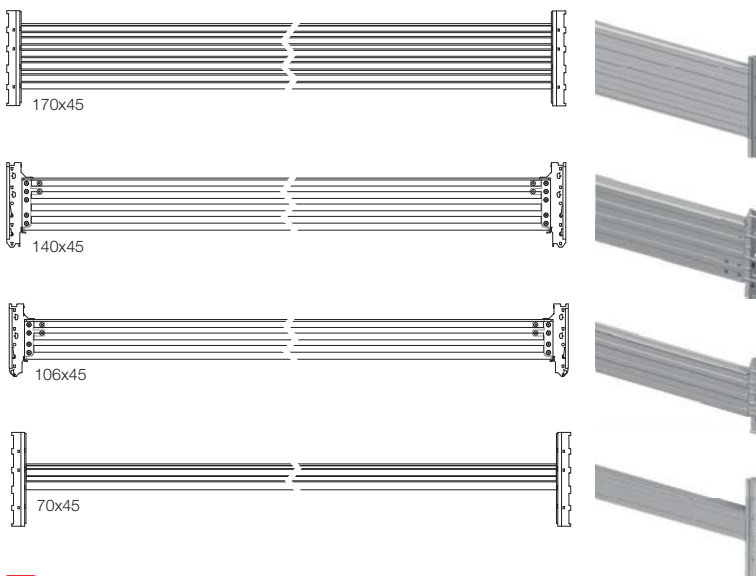

**3** Beams for pallet racking or steel shelf panels



**4** Beam safety pin  
(the use of safety pins is mandatory!)

## Powder coating finish of the beams (standard colour: yellow, RAL 1004)

- Hot wash degreasing and iron phosphate pre treatment;
- Application to thermosetting powder paint;
- Curing at temperature of approximately 240°C in a force ventilated air circulation oven.

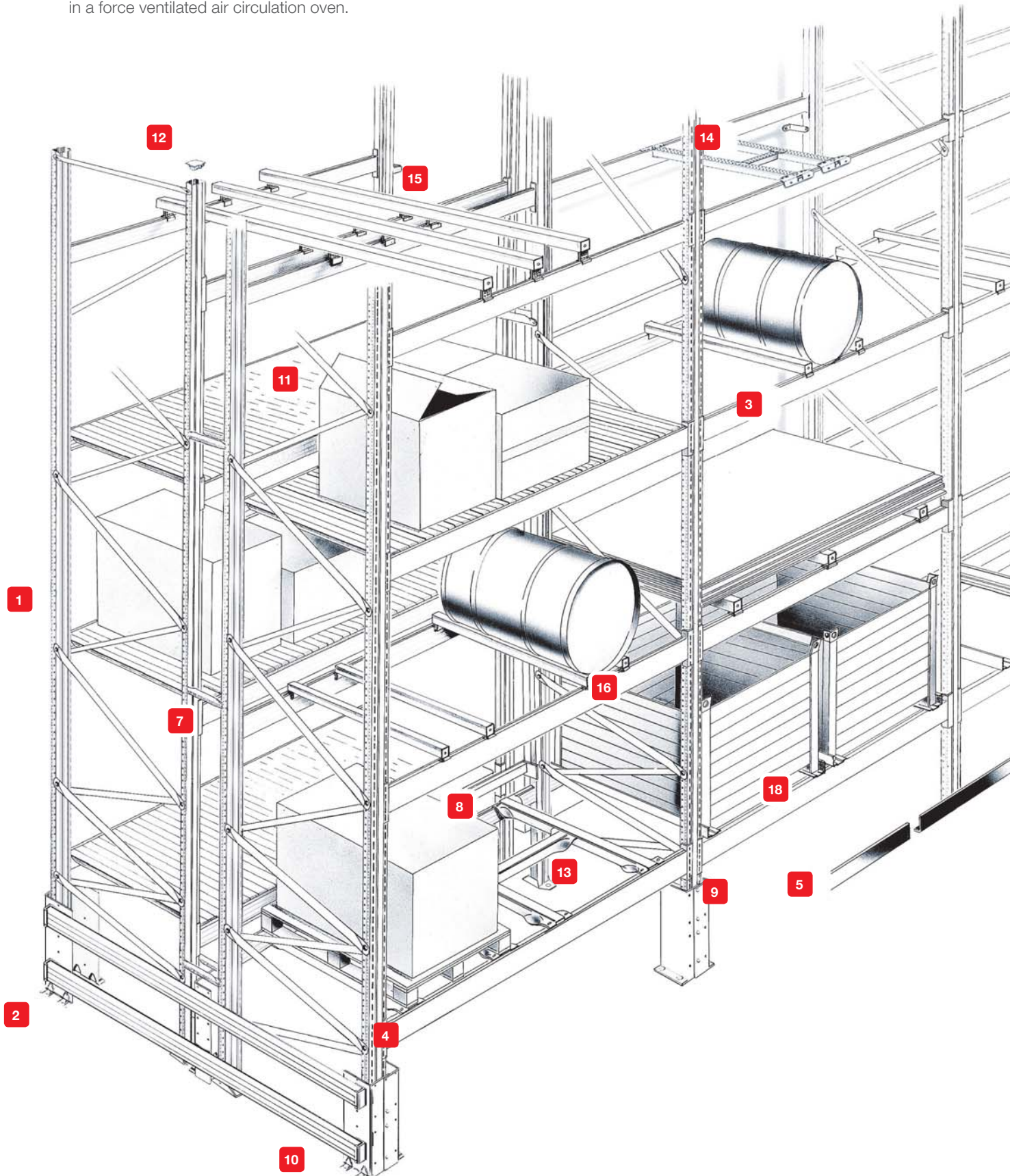

# Accessories

METALSISTEM pallet racking series can be equipped with a vast range of accessories.



**5** Floor mounted guide rail



**6** Load distributor plate

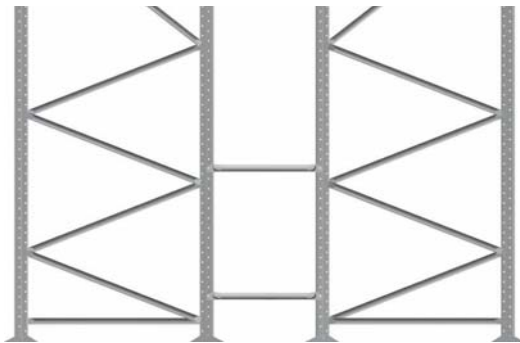

**7** Row spacers

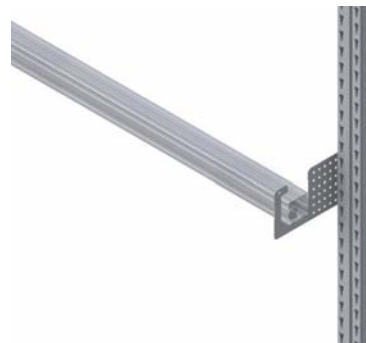

**8** Pallet backstop beam

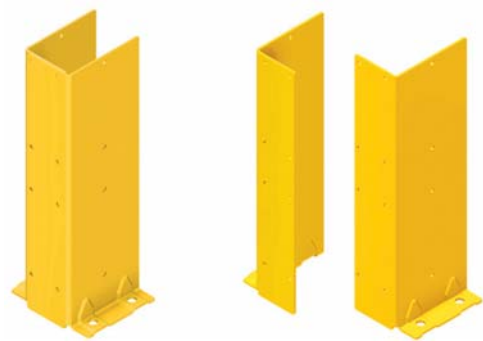

**9** Upright protector

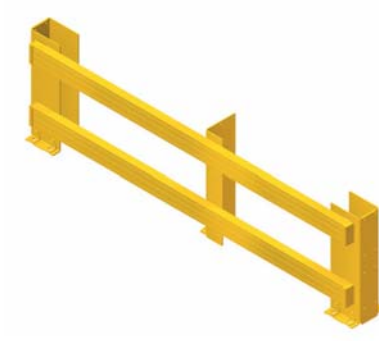

**10** Double frame protector



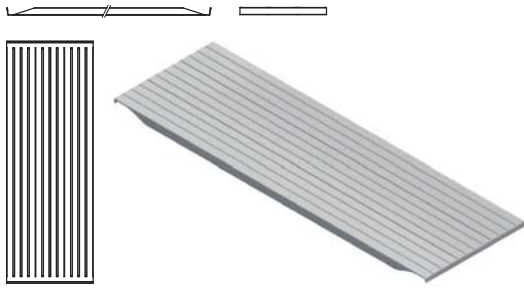

**11** Modular steel shelf panel H25 / H29 with flanged edges



**12** Plastic top cap

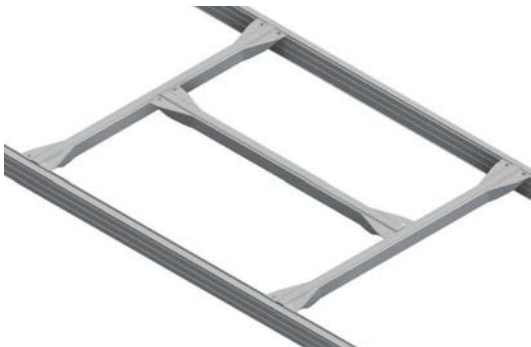

**13** Combined pallet support bars

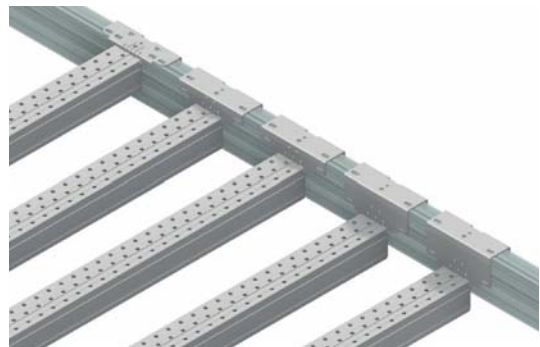

**14** Flush fit and lowered 70 x 70 pallet support bars



**15** Raised pallet support bars

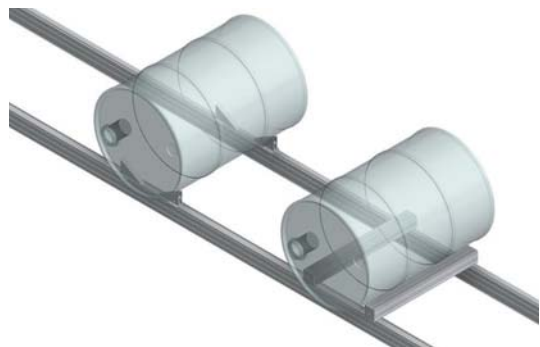

**16** Drum cradle / Drum wedges



**17** Lightened secondary beams \*  
\* for use in installations equipped with sprinkler systems (shelf surface with < 50% coverage)



**18** Bin cradle

# Drive-In

The DRIVE-IN racking system allows the maximum use of space and volume due to the elimination of access aisles.

The storage volume is therefore more than doubled compared with standard pallet racking.

Two kinds of installation are possible: DRIVE-IN and DRIVE-THROUGH.

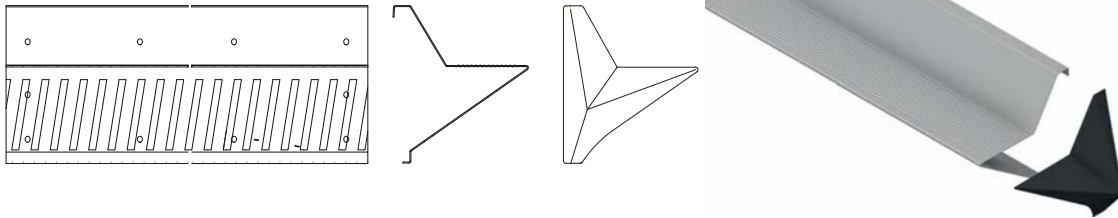
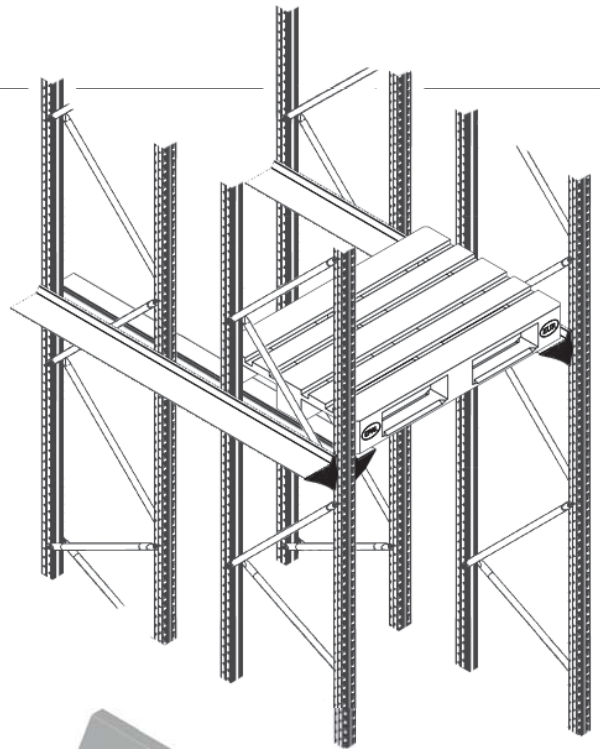

**19** Drive-in guide rail | Entrance crescent

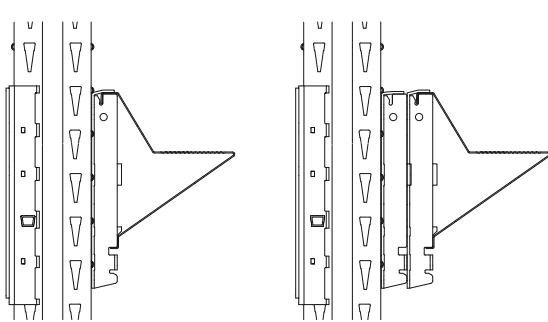

**20** DRIVE-IN guide rail located on a single and double bracket

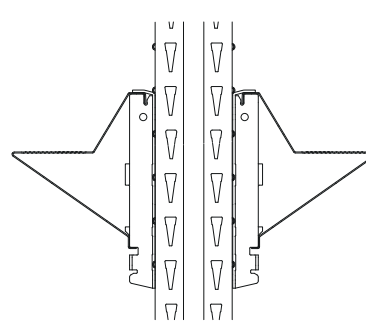

**21** Double sided DRIVE-IN guide rails located on single brackets

# Push Back

All METALSISTEM pallet racking series are perfectly suitable for PUSH-BACK installations, providing increased usage flexibility and pallet accessibility across both tunnels and storage levels in height.

Stability, storage density, low maintenance cost, ease of use are but a few of the outstanding features of PUSH-BACK installations.



See more on the web

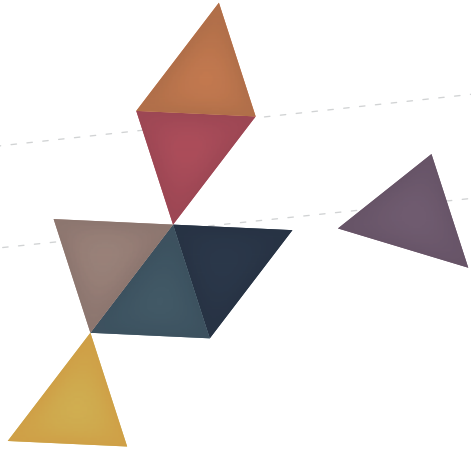

**METALSISTEM**®  
STRUTTURE ED AUTOMAZIONE  
MADE IN ITALY 

METALSISTEM S.p.A.  
38068 Rovereto (Tn) - Viale dell'Industria, 2 - Italy  
Tel. +39 0464 303030 - Fax +39 0464 303031  
info@metalsistem.com - www.metalsistem.com

VERSIONE 03 | DATA VERSIONE 05/2016 | DATA STAMPA 05/2016 | CODICE INGROSSO 00938